

SIMPLE, RELIABLE AND EASY TO INSTALL

Technical manual

Mounting IMS-Solar on an unisolated and isolated steel roof.

CORRUGATED

STEEL

ROOF TILE

Simple, reliable and easy to install in 5 steps on a steel roof

- 1** Measure, stake out and drill
- 2** Riveting IP-fix
- 3** Click IP insert profiles
- 4** Click cable bracket and opti bracket
- 5** Insert solar panels

Index

1. General installation conditions	03	2. Parts overview	06
<ul style="list-style-type: none"> ■ General information ■ Stability and conditions of the roof ■ Safety warnings ■ Coverage of application in the Netherlands ■ Wind load ■ Standards, regulations and legislation ■ Removal and disassembly ■ Warranty ■ Liability 	<ul style="list-style-type: none"> 03 03 04 04 05 05 05 05 05 	<ul style="list-style-type: none"> 3. Installing IMS-Solar ■ Tools required ■ Installation ■ Step 1: Measure, stake out and drill ■ Step 2: Riveting IP-fix ■ Step 3: Click IP insert profiles ■ Step 4: Mounting cable bracket and opti bracket ■ Step 5: Insert solar panels 	<ul style="list-style-type: none"> 07 07 07 08 08 09 09 10



This extensive manual describes the installation of the mounting system for solar panels on a steel roof. Follow these instructions carefully and perform the actions in the correct order. If you lose the manual, you can always download it from www.ims-solar.com.

1. General installation conditions

General information

All information, data and advises from this manual are binding. IMS-Solar remains the right to revise the manual based at developments or experiences of everyone involved.

Should you not comply to the rules stated in this document may cause all warranty and product liability claims to become void.

Stability and conditions of the roof

It's important to check the conditions of the roof upfront. The roof should be in good condition and should have enough strength to bear the weight of the solar panels including additional materials. In addition, the roof must also meet the standards for wind and snow load. Please note that the load reserve of the roof is not exceeded anywhere. Check the stability of the roof and adjust if necessary. If in doubt, contact a specialist.

Safety warnings

- Installation should be carried out by qualified technical constructors.
- Before starting installation the roof should be clean, dry etc.
- Should installation take place at a slanted roof please make sure to use fall protection materials such as edge protection and safety nets.
- If the surface of the roof is slippery due to rain or there is a strong wind, please avoid installation!
- It is recommended to follow the drawings in detail. Omitting or adding parts at your discretion may negatively affect the functioning of the mounting system and is therefore strongly discouraged!
- Chlorine fumes, aggressive fumes and fumes from rotting fruit can affect the durability of the rivets. IMS-Solar recommends choosing a different mounting method if these vapors are present.
- Place rubber fuses at the top between the panels if the slope of the panels is less than 10 degrees. With less slope, the pressure underneath is less; this prevents movement.
- Always wear appropriate protective shoes and clothing.

- Always wear work gloves for protection. Also to avoid damage to the solar panels; don't hold them without gloves.
- Never stand in a gutter!
- Use a lifting aid/lift installation to move materials.
- Use of a ladder should always take place on a solid surface and should be placed at an angle of 75 degrees, about one meter sticking out above the roof edge. Secure the top of the ladder by using a rope or fastener if possible.
- Please make sure to be informed about the last developments by checking the most recent version of the manual and guarantees.

Coverage of application in the Netherlands

- Solar panels: of all brands and models with a frame height of 30 or 35 mm.
- Wind zones: 1 to 3, terrain category II en III (NEN 1991-1-4).
- Roof height: 3 - 15 m. Should the roof be higher please contact your supplier.
- Type of roof: corrugated roof.
- Slope of the roof: between 15 - 60 degrees (35 degrees will be optimal).



- Coastline
- Wind zone 1
- Wind zone 2
- Wind zone 3



Terrain category 0

Sea or coastal area with winds coming over the open sea.



Terrain category II

Area with low vegetation such as grass and freestanding obstacles (trees, buildings) with a spacing of at least 20 obstacle heights.



Terrain category III

Area with regular vegetation or buildings or isolated obstacles with spacing of no more than 20 obstacle heights (such as villages, suburban terrain, permanent forest).

Windload

Due to the influence of the wind, the distance of the solar panels to the top and bottom of the roof is at least 30 cm. The same applies for the distance of the solar panels to both sides of the roof. Please do not place solar panels partly or entirely within this area! Also think about sufficient room to move for maintenance work.

Standards, regulations and legislation in the Netherlands

To prevent accidents it's important to follow the mounting manual and regulations. Please pay attention to the below norms, regulations and legislation.

- **NEN 7250:2014** Constructive aspects solar-energy systems
- **NEN-EN 1990** Basis of the constructive design
- **NEN-EN 1991-1-3** General weight: snow
- **NEN-EN 1991-1-4** General weight: wind
- **NEN 1010:2015** Electrical installations for low voltage (HD-IEC 60364)
- **NEN-EN-IEC 62305** Lightning protection
- **Arbowet en Arboregeling** Safety labour and social affairs
- **NEN 3140** Safety management low voltage installations
- **Checklist VCA** Safe operation at location
- **Regulations scaffolds and ladders**

Removal and disassembly

Removal of the products accordingly to local laws and regulations

Warranty

Warranty according to the general conditions of IMS-Solar BV can be found at www.ims-solar.com.

Liability

IMS-Solar BV shall not be held liable for any damage or injury caused by a failure to not (strictly) comply with our safety regulations and instructions in this manual or due to negligence during installation our product and/or any involved accessories.

2. Parts overview

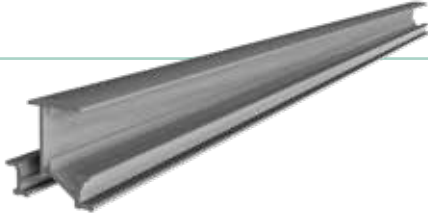

- **14031** IP-30 insert profile 6,2m
Dimensions: 6200 x 52,9 x 51,93 mm



- **14032** IP-30 insert profile black 6,2m
Dimensions: 6200 x 52,9 x 51,93 mm

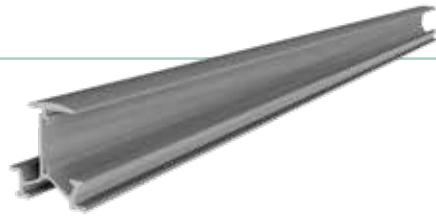

- **14051** IP-35 insert profile 6,2m
Dimensions: 6200 x 52,9 x 56,93 mm



- **14052** IP-30 insert profile black 6,2m
Dimensions: 6200 x 52,9 x 56,93 mm



- **14041** IP-30 insert profile light 6,2m
Dimensions: 6200 x 52,9 x 44,8 mm



- **14042** IP-30 insert profile light black 6,2m
Dimensions: 6200 x 52,9 x 44,8 mm



- **14061** IP-35 insert profile light 6,2m
Dimensions: 6200 x 52,9 x 49,8 mm



- **14062** IP-35 insert profile light black 6,2m
Dimensions: 6200 x 52,9 x 49,8 mm

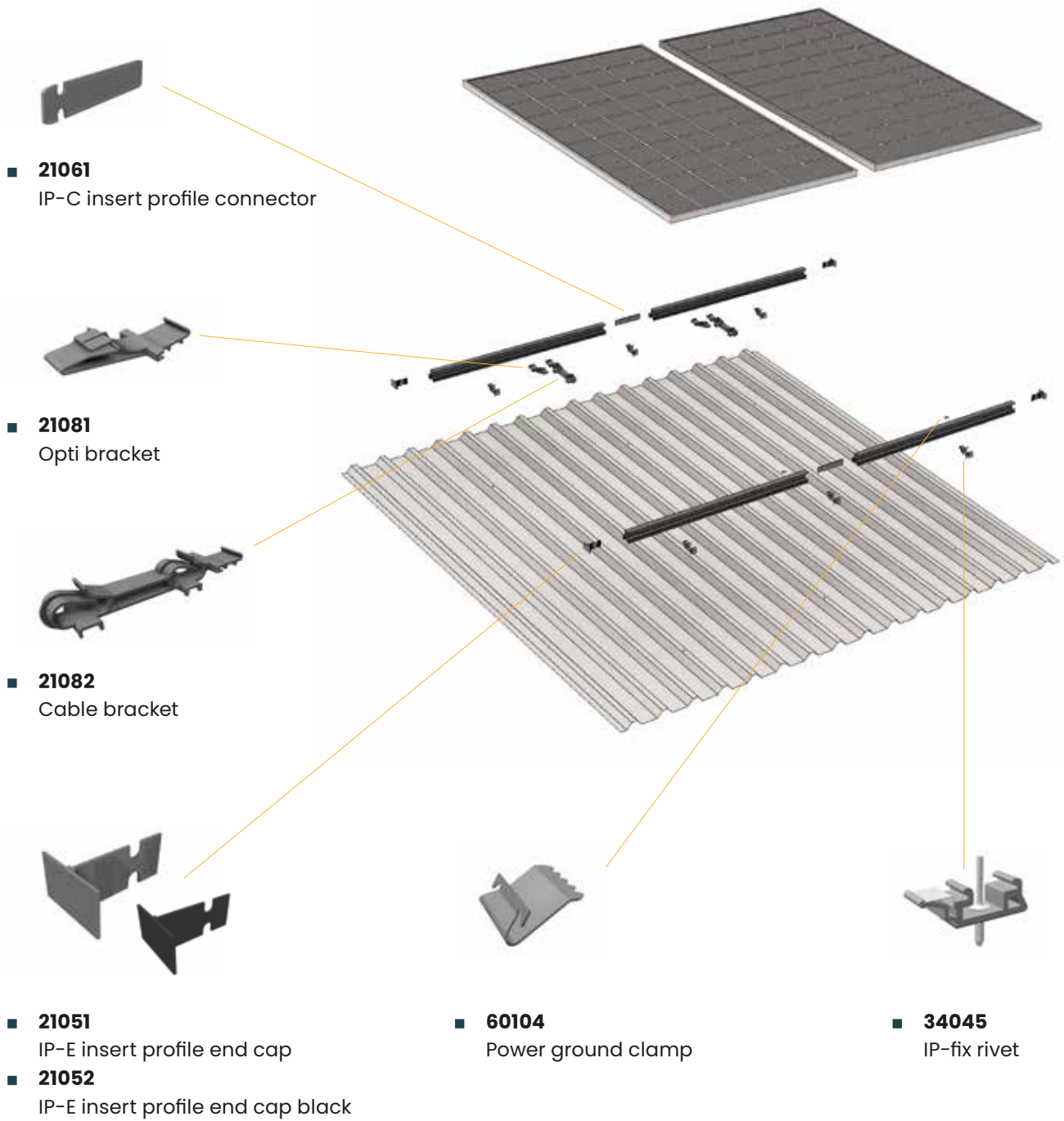

■ **21061**
IP-C insert profile connector

■ **21081**
Opti bracket

■ **21082**
Cable bracket

■ **21051**
IP-E insert profile end cap

■ **21052**
IP-E insert profile end cap black

■ **60104**
Power ground clamp

■ **34045**
IP-fix rivet

■ **60101**
Use the IMS mounting tool for securing various parts. Make sure you use the right movement as described; upwards or downwards.



3. Installing IMS-Solar

Tools required



Drillmaster



Riveting tool



IMS mounting tool



Pencil



Measure tape

Installation

Before installing the mounting materials the roof sheets need to be cleaned with a brush. Remove algae, moss and debris to reduce unevenness during the installation. The position of the roof compared to the sun is essential to receive optimal results. Surrounding buildings or trees can create shade, which will have a negative effect on the result and efficiency of the solar panels. Therefore, check the surroundings in advance.

This manual is only suitable for unisolated and isolated steel roofs.

In preparation, it is important to adjust the drill size (mold) to the size of the solar panel + 14 mm (module size). Use of the mold is advised to prevent the drill from slipping. It is important that the rubber rings on the cross joint are adjusted so that they rest on a raised rib of the roof. This protects both the roof and the drilling mold from damage during installation.

The drill guide on the right side must be aligned so that the position of the drill hole is above the horizontal center of the raised rib of the trapezoidal sheet. The vertical spacing between the drill holes is the vertical height of the solar panel + 14 mm.

Step 1. Measure, stake out and drill

As indicated earlier, it is important that the distance of the solar panels to the top and bottom of the roof is at least 30 cm.

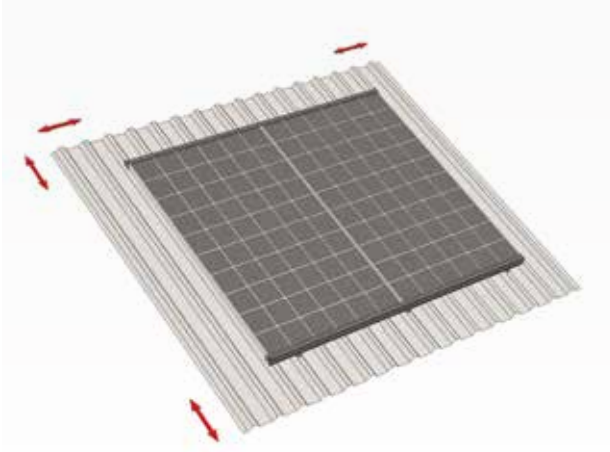

The same applies for the distance of the solar panels to both sides of the roof. It is important to first check the carrying capacity of the substructure. After that, the module field can be measured based on the outcome of the IMS calculation program. Mark the positions of the first and last IP-fix on the bottom row.

Use the drilling mold to determine the exact position and prevent the drill from slipping. The drill size is 6.5 mm; with this size the first and last IP fix on the bottom row are pre-drilled.

Place the positioning pins in the first and last drilled hole and stretch a string between them. This indicates the bottom row of IP-fix. Now the mounting points on the raised ribs can be marked in the correct position.

Insert the positioning pin through the drilling mold into the pre-drilled hole of the bottom row of IP-fix; this allows you to move from position to position both vertically and horizontally, so that the exact location of the drill-hole can be determined and drilled. Horizontally it is important to first determine the position of the first and last raised rib in order to stretch a string between them as well.

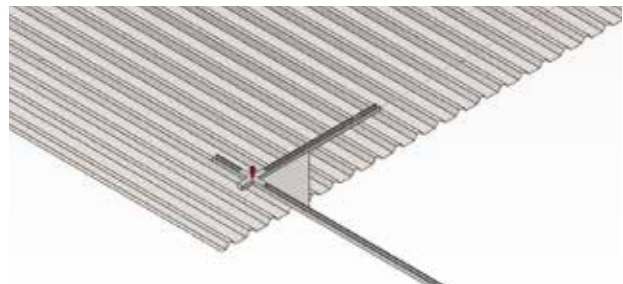



Step 2. Riveting IP-fix

Rive the IP-fix into the pre-drilled holes. It is important that the metal spring is pointing upwards. For mounting the IP-fix, use the rubber underlay, the rivet and a cordless riveting tool. The rivet and IP-fix are mounted using the riveting tool.

It is important to use a rivet nose piece for the IMS-Solar sealing rivets.



Step 3. Click IP insert profiles

When all IP-fix are mounted, the horizontal IP insert profiles can easily be clicked into place from top to bottom with the wider part of the front always pointing downwards.

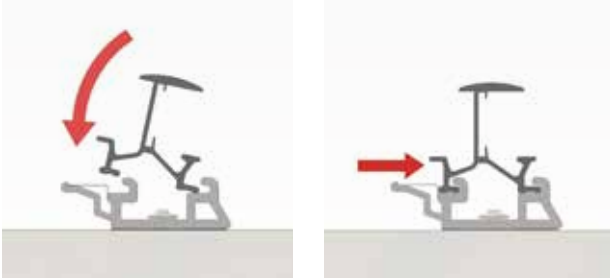

Prevent the rails from sliding due to heat or cold by securing only 1 (the middle) IP-fix per IP insert profile. Use the mounting tool to bend the IP insert profile, both left and right of the IP-fix, by moving downwards.



If the setup is wider than 6,2 meters, the IP insert profiles must be connected to each other with the IP-C insert profile connector. This is pushed in from the side halfway between the raised edges in the already mounted profile. Then secure it on one side by making the correct movement upwards with the mounting tool (make sure that this lock is on the same side in all connections).

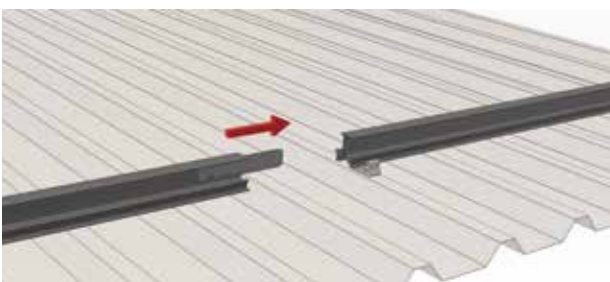

The next IP insert profile slides over the protruding part of the IP-C insert profile connector in such a way that a space of at least 5 mm between the two IP insert profiles remains open. This allows the IP insert profile to expand with heat and contract with cold. The system can continue to carry the load of the module without too much stress being applied.

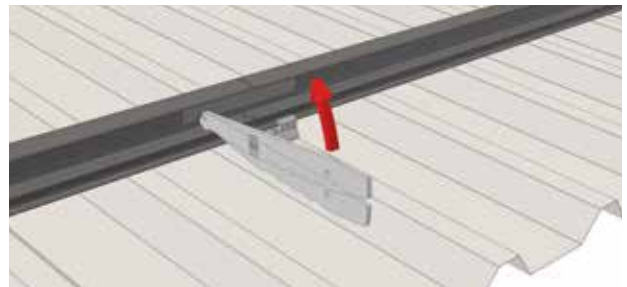

Then the IP-E insert profile end caps can be mounted. Slide it in from the side between the raised edges until it can go no further. Secure the IP-E insert profile end caps by moving the mounting tool upwards.

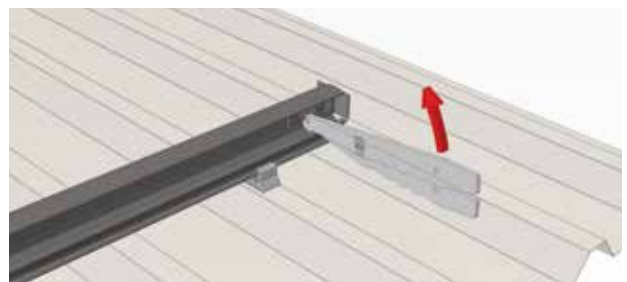
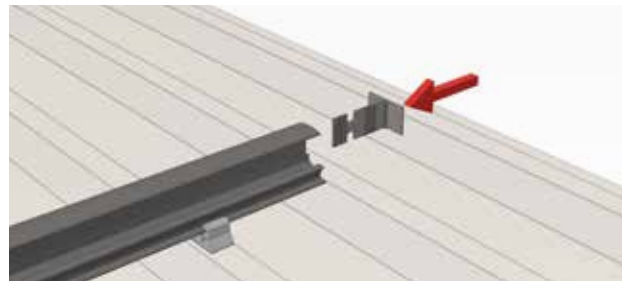

Step 4. Mounting cable bracket and opti bracket

Install cable bracket

- Click the cable bracket onto the IP insert profile by first hooking it onto the back and then clicking it upwards at the front.
- Slide the cables into the conductor, the 'plus' into one and the 'minus' into the other. Fasten with the ty-raps.



Install opti bracket

- Click the opti bracket onto the IP insert profile by first hooking it to the back and then clicking it upwards at the front.
- Click the optimizer onto the bracket.
- Connect the optimizer.

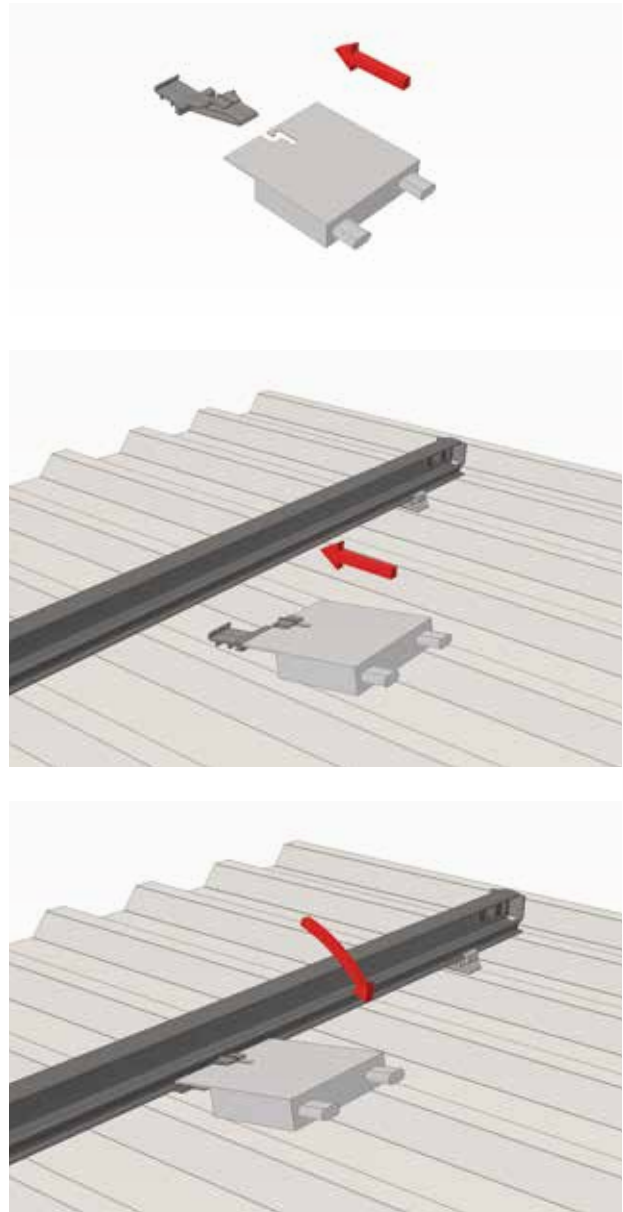

Step 5. Insert solar panels

When all IP insert profiles are attached, the solar panels can be inserted. Make sure that one power ground clamp is slid onto the IP insert profile to ground each solar panel.

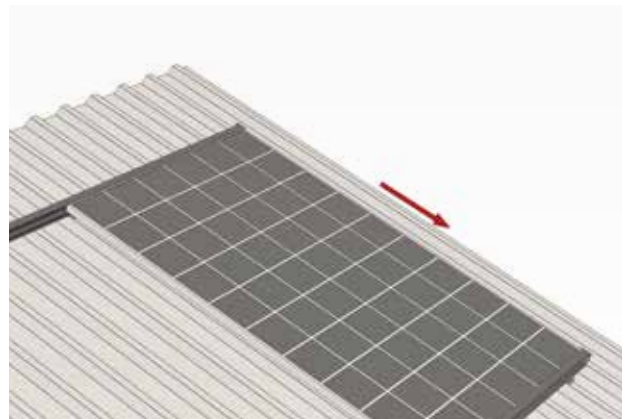
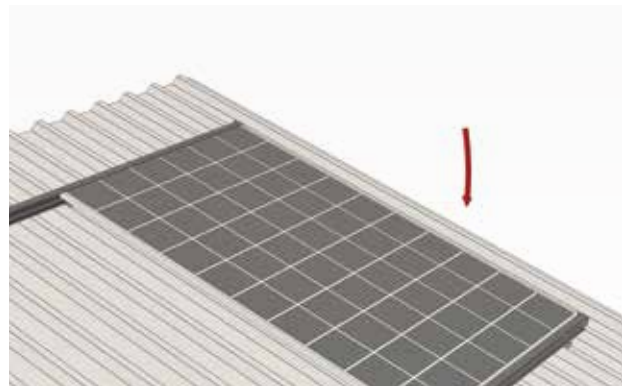
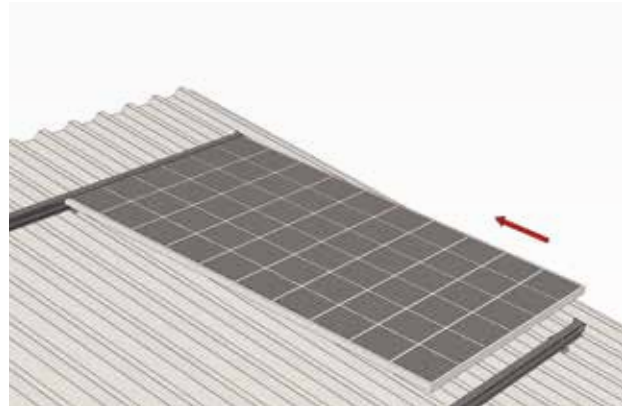
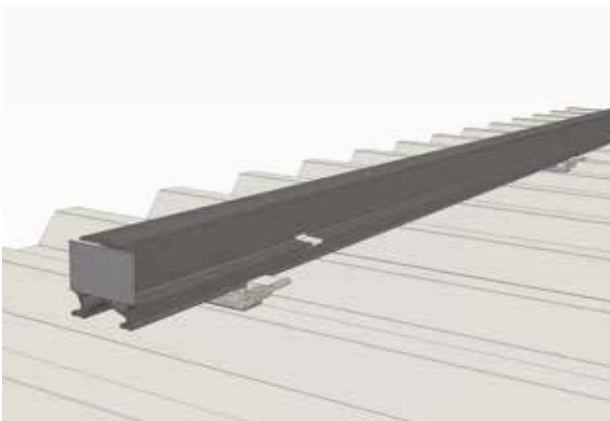

Insert the solar panel into the upper IP insert profile and then lower it into the lower part. Slide the module downwards so that the solar panel is located both above and below in the profile. This way they are held in place by gravity and therefore do not need to be secured further. If the angle is less than 10 degrees, place a rubber fuse at the top between the panels. The next panel can now be slid in and installed, right next to the panel that is already there.



Wognumsebuurt 10, B.0.1.
1817 BH Alkmaar
The Netherlands
info@ims-solar.com
www.ims-solar.com
+31(0)6 536 489 71